



MANUAL  
**CV500L**  
GAMING CASE



# **IMPORTANTE**

**É DE EXTREMA IMPORTÂNCIA LER, COMPREENDER E SEGUIR TODAS AS INSTRUÇÕES CONTIDAS NESTE MANUAL. O MANUSEIO INCORRETO PODE DANIFICAR O EQUIPAMENTO E OCASIONAR A ANULAÇÃO DA GARANTIA.**

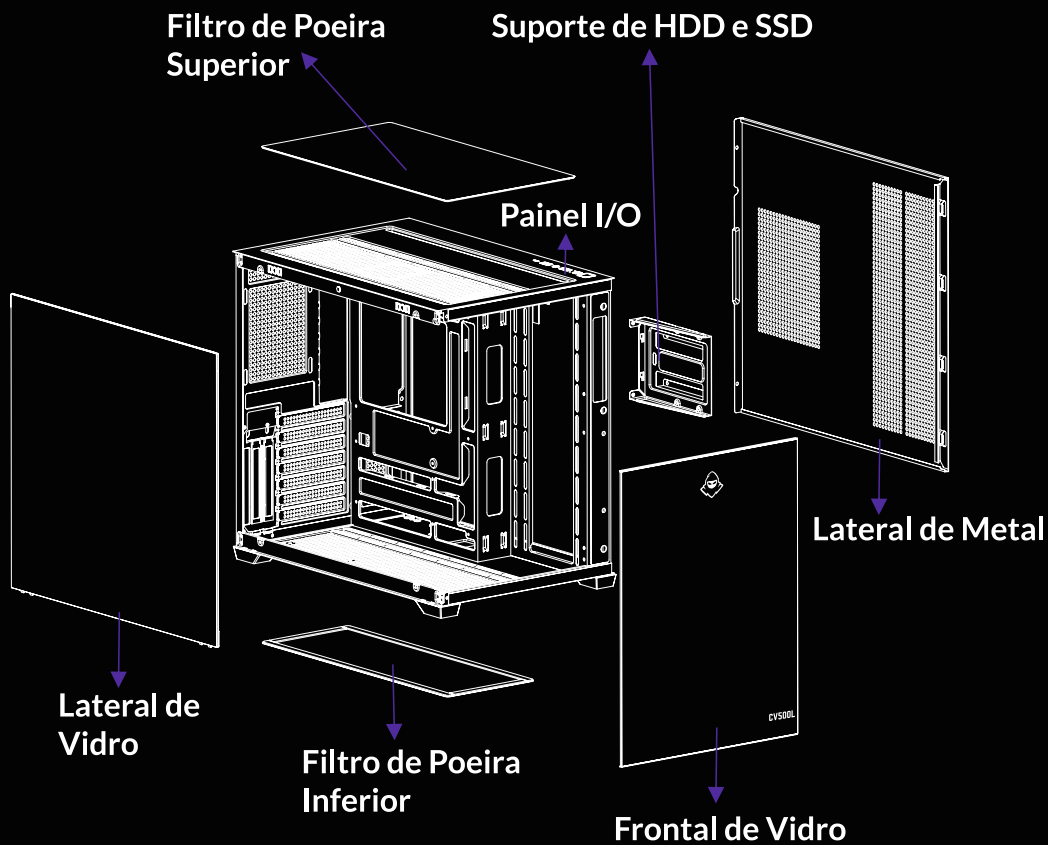
# COMPONENTES DO HARDWARE



# ACESSÓRIOS

	Parafusos para Fonte de Alimentação	x6
	Parafusos para Placa-Mãe e SSD	x20
	Parafusos para HDD	x5
	Espaçadores para fixação da Placa-Mãe	x3
	Braçadeiras para gerenciamento dos Cabos	x5
	Parafuso de fixação para Placa de Vídeo em orientação vertical	x2
	Presilhas de Fixação	x2

# ABERTURA DO GABINETE

A lateral de vidro possui um encaixe prático, basta destacá-la cuidadosamente pela parte superior para removê-la.

Para remover a lateral de metal, é necessário desparafusar os 2 parafusos traseiros.

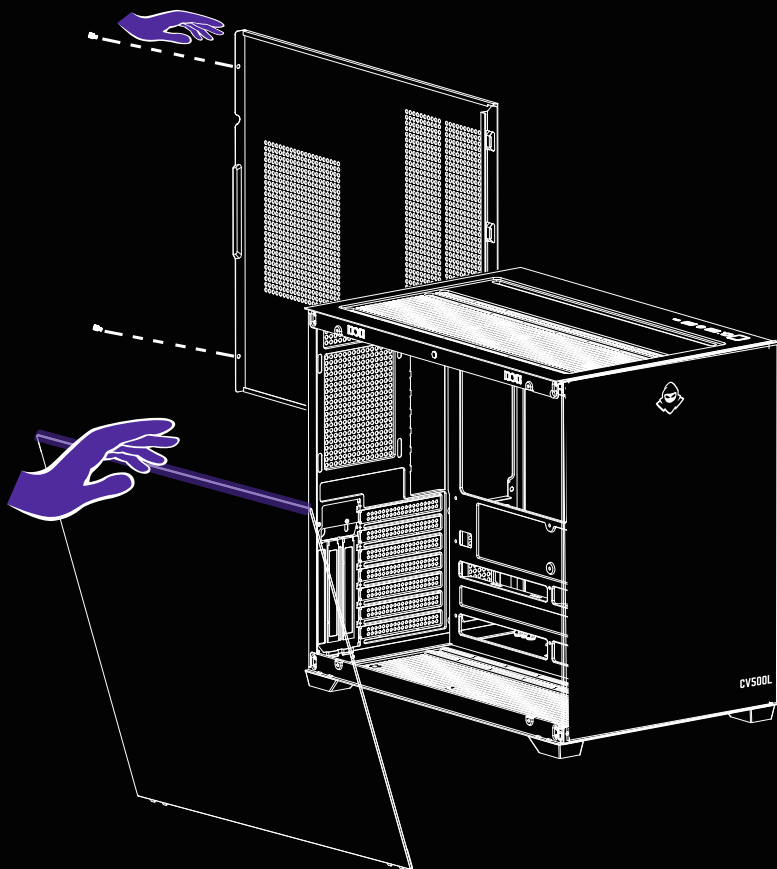

# INSTALAÇÃO DA PLACA-MÃE

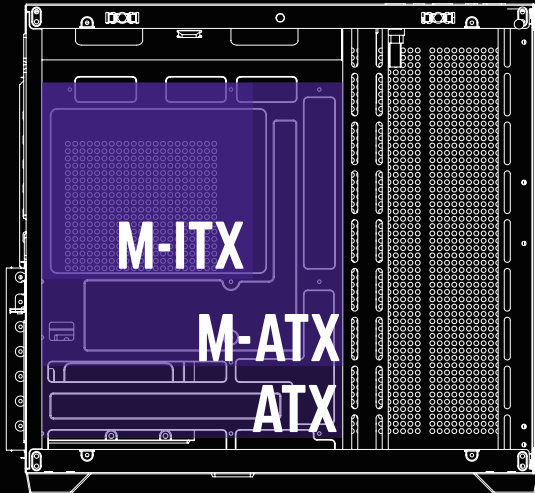

Posicione a Placa-Mãe alinhando suas furações com as do local de instalação, reposicione os espaçadores se necessário, e fixe com os respectivos parafusos.

# INSTALAÇÃO DE HDD 3.5" E SSD 2.5"

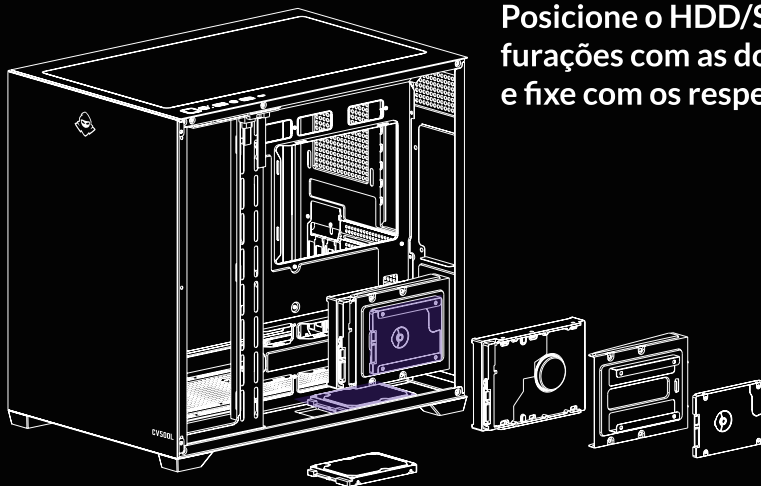

Posicione o HDD/SSD alinhando suas furações com as do local de instalação, e fixe com os respectivos parafusos.

# INSTALAÇÃO DAS VENTOINHAS E WATER COOLER

Posicione a Ventoinha/Water Cooler alinhando suas furações com a do local de instalação, e fixe com os respectivos parafusos.

**Ventoinha Superior: 3x 120mm ou 2x 140mm**

**Water Cooler: Até 360mm**

**Ventoinha  
Traseira:  
1x 120mm**

**Water  
Cooler:  
120mm**

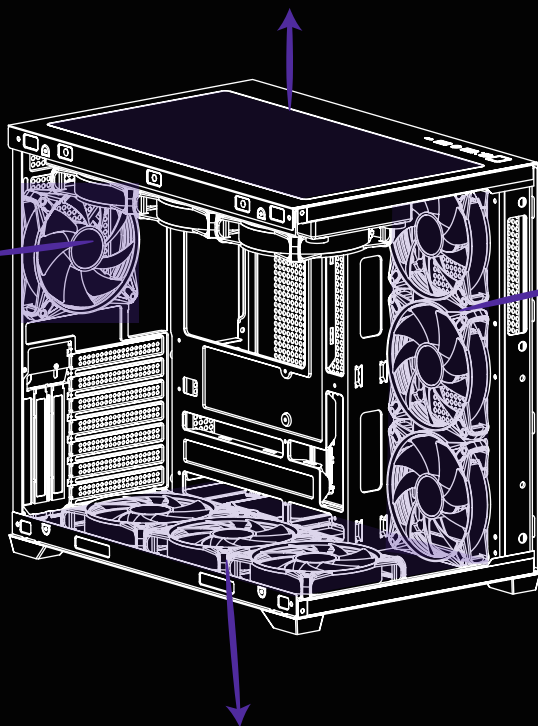

**Ventoinha  
Lateral:  
3x 120mm**

**Water  
Cooler:  
Até 240mm**

**Ventoinha Inferior: 3x 120mm ou 2x 140mm**

**Water Cooler: Até 360mm**

# INSTALAÇÃO DA FONTE DE ALIMENTAÇÃO

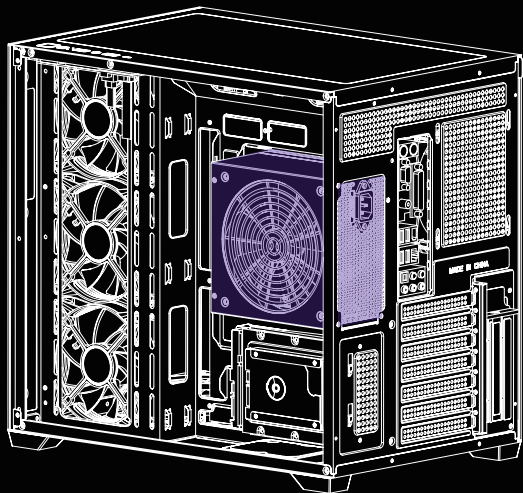

Remova a lateral de metal para ter acesso ao local de instalação, posicione a Fonte de Alimentação alinhando suas furações com o local de instalação, e fixe com os respectivos parafusos pela parte traseira do gabinete.

# INSTALAÇÃO DA PLACA DE VÍDEO

Identifique e remova os slots de expansão que o modelo da Placa de Vídeo irá utilizar, conecte a Placa de Vídeo na Placa-Mãe, e fixe com os respectivos parafusos pela parte traseira do gabinete.

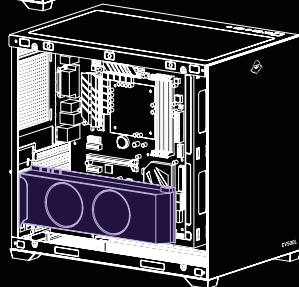
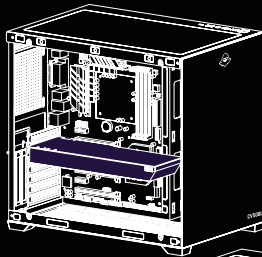



# PAINEL I/O

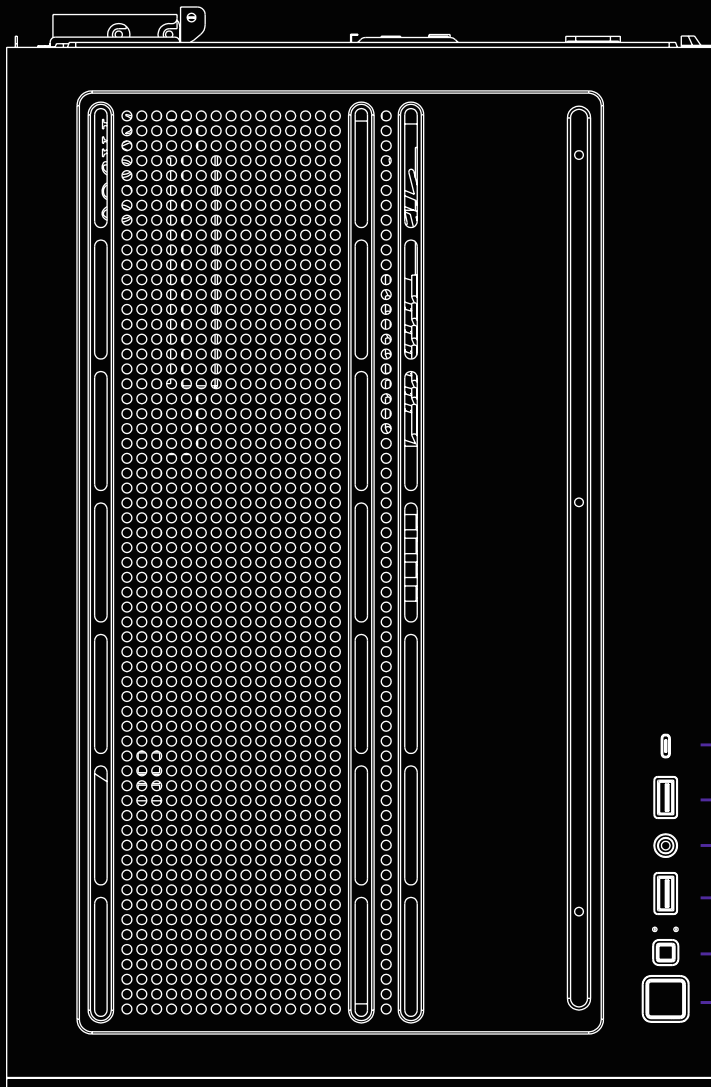

Tipo-C



USB 3.0



Áudio HD



USB 2.0



RESET



POWER

# CONECTORES

## Conector de Áudio HD do Gabinete



## Conector de Áudio HD da Placa-Mãe



## Conector USB 2.0 do Gabinete



## Conector USB 2.0 da Placa-Mãe



## Conector USB 3.0 do Gabinete

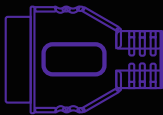

## Conector USB 3.0 da Placa-Mãe



## Conector Tipo-C do Gabinete

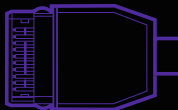

## Conector Tipo-C da Placa-Mãe

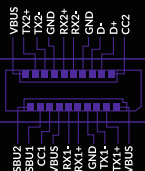

## Conector Power/Reset/LED do Gabinete

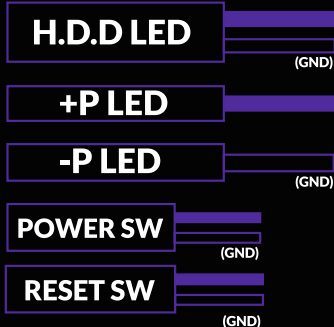

## Conector Power/Reset/LED da Placa-Mãe



**AGRADECEMOS POR ESCOLHER O PICHAU GROUP  
COMO PARTE DA SUA JORNADA.**



**MANCER**



**Pichau**

**EXPLORE NOSSOS SITES E ENCONTRE O  
PRODUTO IDEAL PARA ELEVAR SUA EXPERIÊNCIA.**

