



**MANUAL**  
**CV550**  
**GAMING CASE**



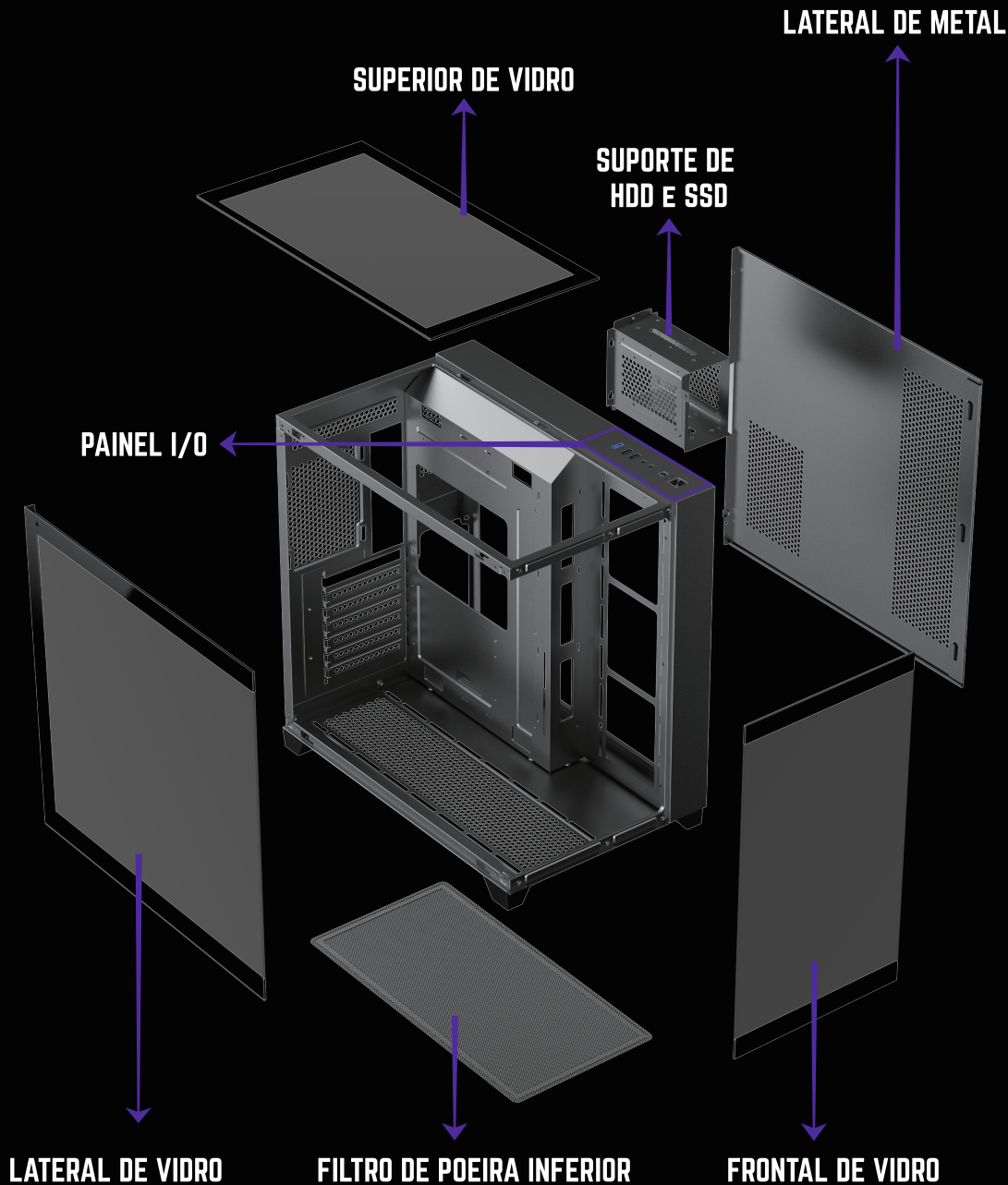

# IMPORTANTE

**É DE EXTREMA IMPORTÂNCIA LER, COMPREENDER E SEGUIR TODAS AS INSTRUÇÕES CONTIDAS NESTE MANUAL. O MANUSEIO INCORRETO PODE DANIFICAR O EQUIPAMENTO E OCASIONAR A ANULAÇÃO DA GARANTIA.**





# ACESSÓRIOS

<b>NOME DOS COMPONENTES</b>	<b>QTD</b>	<b>IMAGEM</b>
Espaçadores	3	
Parafusos da Fonte de Alimentação	6	
Parafusos do HDD	8	
Parafusos da Placa-Mãe	16	
Braçadeiras de Plástico	5	

# INSTALAÇÃO DA PLACA-MÃE



Posicione a Placa-Mãe alinhando suas furações com as do gabinete, reposicione os espaçadores se necessário.

Em seguida fixe com os respectivos parafusos.





Posicione o gabinete na horizontal (deitado).



Encaixe o espelho da Placa-Mãe na parte traseira do gabinete.



Em seguida posicione a Placa-Mãe (conforme imagem acima).



Fixe a Placa-Mãe com os parafusos correspondentes.

# INSTALAÇÃO DO SSD 2.5"



Abra os painéis para ter acesso ao local de suporte do SSD.

Posicione o SSD alinhando suas furações com as do gabinete.

Fixe o SSD com os respectivos parafusos.



# INSTALAÇÃO DO HDD 3.5"



Abra o painel direito, local de instalação de até 2 HDDs 3.5"



# MÉTODO DE INSTALAÇÃO DO HDD 1



Posicione o HDD no local de instalação, alinhando suas furações e fixe com os respectivos parafusos.



Fixe o HDD com os respectivos parafusos, pela parte inferior externa do gabinete.



## MÉTODO DE INSTALAÇÃO DO HDD 2

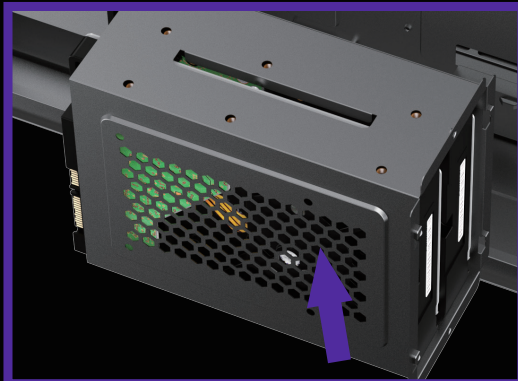

Posicione o HDD, alinhando as furações com as do gabinete.

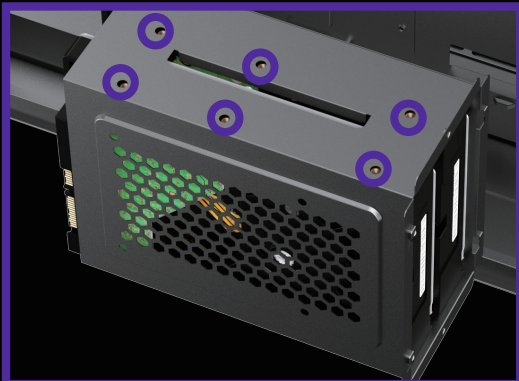

Prenda os 4 parafusos no disco sem parafusá-los até o final.



Deslize o HDD com os parafusos pré-instalados conforme indica a imagem.



Fixe o HDD com os parafusos correspondentes.





# INSTALAÇÃO DAS VENTOINHAS

## SUGESTÃO DE INSTALAÇÃO DAS VENTOINHAS E FLUXO DE AR.

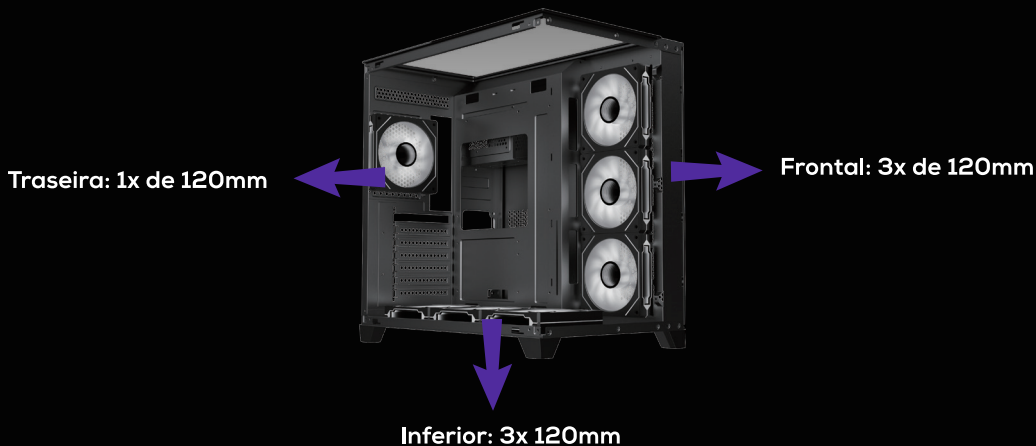
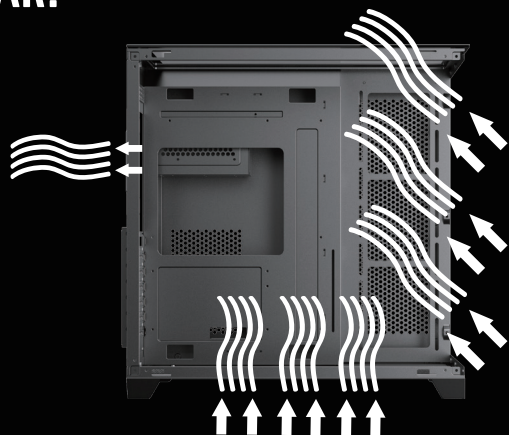

Posicione a Ventoinha/Water Cooler alinhando suas furações com a do local de instalação, e fixe com os respectivos parafusos.

# INSTALAÇÃO DA FONTE DE ALIMENTAÇÃO

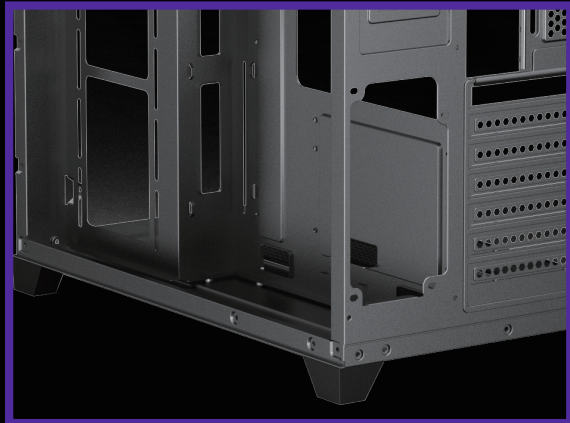

Posicione a fonte, alinhando as furações com as do gabinete.

Use os parafusos para fixá-la pela parte traseira do gabinete, conforme mostra a imagem ao lado.



# PAINEL I/O



Power

Luz de atividade  
de Armazenamento

Reset  
(Botão de LED)

Áudio HD

2x USB 2.0

1x USB 3.0

# CONECTORES

Conector de Áudio HD do Gabinete

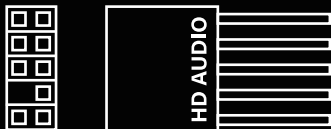

Conector de Áudio HD da Placa-Mãe

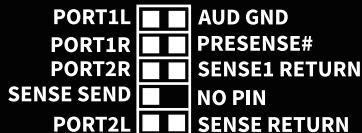

Conector USB 2.0 do Gabinete



Conector USB 2.0 da Placa-Mãe

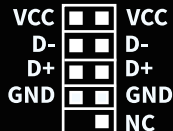

Conector USB 3.0 do Gabinete

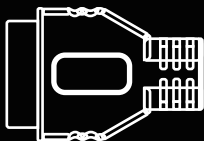

Conector USB 3.0 da Placa-Mãe

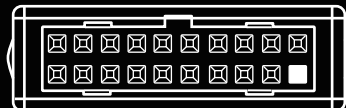

Conector Power/Reset/LED do Gabinete

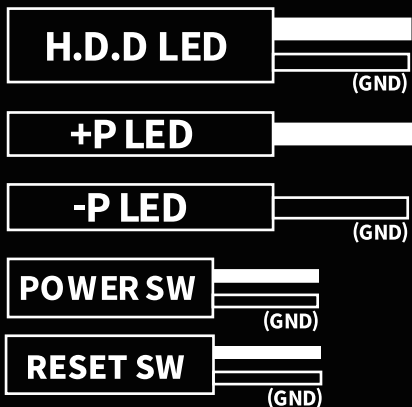

Conector Power/Reset/LED da Placa-Mãe



**AGRADECEMOS POR ESCOLHER O PICHAU GROUP  
COMO PARTE DA SUA JORNADA.**



**MANCERA**



**Pichau**

**EXPLORE NOSSOS SITES E ENCONTRE O  
PRODUTO IDEAL PARA ELEVAR SUA EXPERIÊNCIA.**

